



NANAWALL SL60B AND WA67B

Folding Glass Walls Designed for Builders

SL60B and WA67B are folding glass walls designed to fit the needs of builders—at set pricing. SL60B is an aluminum framed system and WA67B is an aluminum clad wood framed system. SL60B is \$2,100 per panel and WA67B is \$2,400 per panel—without sacrificing the quality, performance, and brand recognition of NanaWall. Transparent pricing allows easy project budgeting—flexible opening sizes from 6' through 15' wide and heights up to 8' 2". Both offer short lead times, providing builders with premium product differentiation for their clients.



EASY ORDER
PROCESS



SHORT LEAD
TIMES

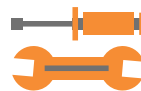

INSTALLATION
SERVICES
AVAILABLE

NanaWall



BUILDER PRICING

SL60B:
\$2,100*
 PER PANEL

WA67B:
\$2,400*
 PER PANEL

NanaWall

**Pricing subject to change without notice.
 Excluding tax, freight, screens, and installation.*

SIZING & CONFIGURATIONS

OPENING FRAME WIDTH	# OF PANELS
up to 6' (1830 mm)	2
up to 9' (2745 mm)	3
up to 12' (3660 mm)	4
up to 15' (4570 mm)	5
Unit Heights up to 8' 2" (2500 mm)	

Panels as viewed from the inside:

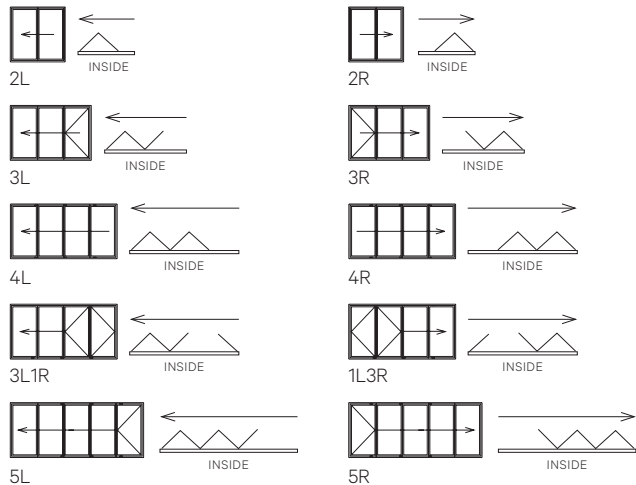

TWO SILL CHOICES

Aluminum Framed SL60B

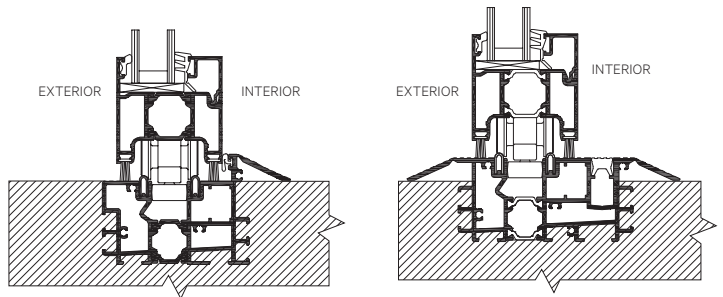

Hybrid Sill

Low Profile Saddle Sill

Aluminum Clad Wood Framed WA67B

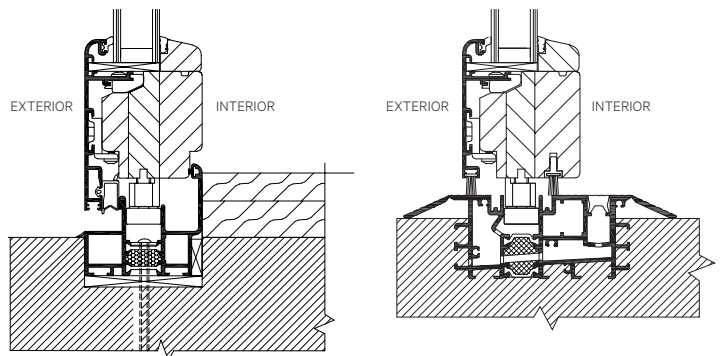

Raised Sill

Low Profile Saddle Sill

THREE POWDER COAT COLOR OPTIONS**

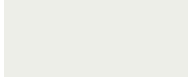

Traffic White



Dark Anodized Bronze



Jet Black

WOOD FINISH OPTION**

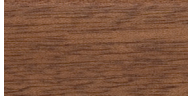

Sapeli Mahogany

***For accurate color swatch and wood finish examples, please request our Powder Coating Finish Options brochure and Wood & Finish Options brochure.*

HARDWARE

Brushed Satin Finish



Handle on swing door

The Traffic White profile finish comes with brushed satin hardware and an anodized aluminum sill.

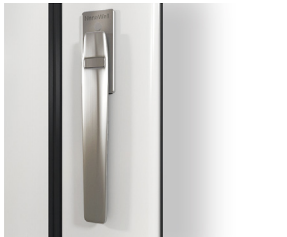

Handle on bifold panel



Black Titanium Finish



Handle on swing door

Jet Black and Dark Bronze finishes come with black titanium hardware with a bronze finished aluminum sill.



Handle on bifold panel



PERFORMANCE

SL60B

(Testing data for Hybrid Sill. See NanaWall.com for Low Profile Sill data)

WA67B

(Testing data for Raised Sill. See NanaWall.com for Low Profile Sill data)



0.30

0.30/0.31



@1.57 psf: 0.02
@6.24 psf: 0.07

@1.57 psf: 0.19
@6.24 psf: 0.31



No uncontrolled water entry at 7.5 psf

No uncontrolled water entry at 7.5 psf



Positive @45 psf
Negative @45 psf

Positive @70 psf
Negative @45 psf



In accordance with AAMA -1304 requirements

In accordance with AAMA -1304 requirements



Cycle Tested 20,000

Cycle Tested 20,000

U-VALUE	
0.30	0.30/0.31
AIR INFILTRATION	
@1.57 psf: 0.02 @6.24 psf: 0.07	@1.57 psf: 0.19 @6.24 psf: 0.31
WATER RATING	
No uncontrolled water entry at 7.5 psf	No uncontrolled water entry at 7.5 psf
DESIGN WIND LOAD	
Positive @45 psf Negative @45 psf	Positive @70 psf Negative @45 psf
FORCED ENTRY	
In accordance with AAMA -1304 requirements	In accordance with AAMA -1304 requirements
LIFE CYCLE TESTING	
Cycle Tested 20,000	Cycle Tested 20,000

NANAWALL TECHNOLOGY

SL60B system weight rides on the floor track, eliminating the need for costly header modifications. WA67B features a back ventilated rain screen technique to protect and isolate the wood from moisture.

OPTIONAL SCREEN AVAILABLE IN MATCHING PROFILE COLORS

INSTALLATION

We offer a nationwide network of NanaWall Certified Installers and a dedicated installation support line.

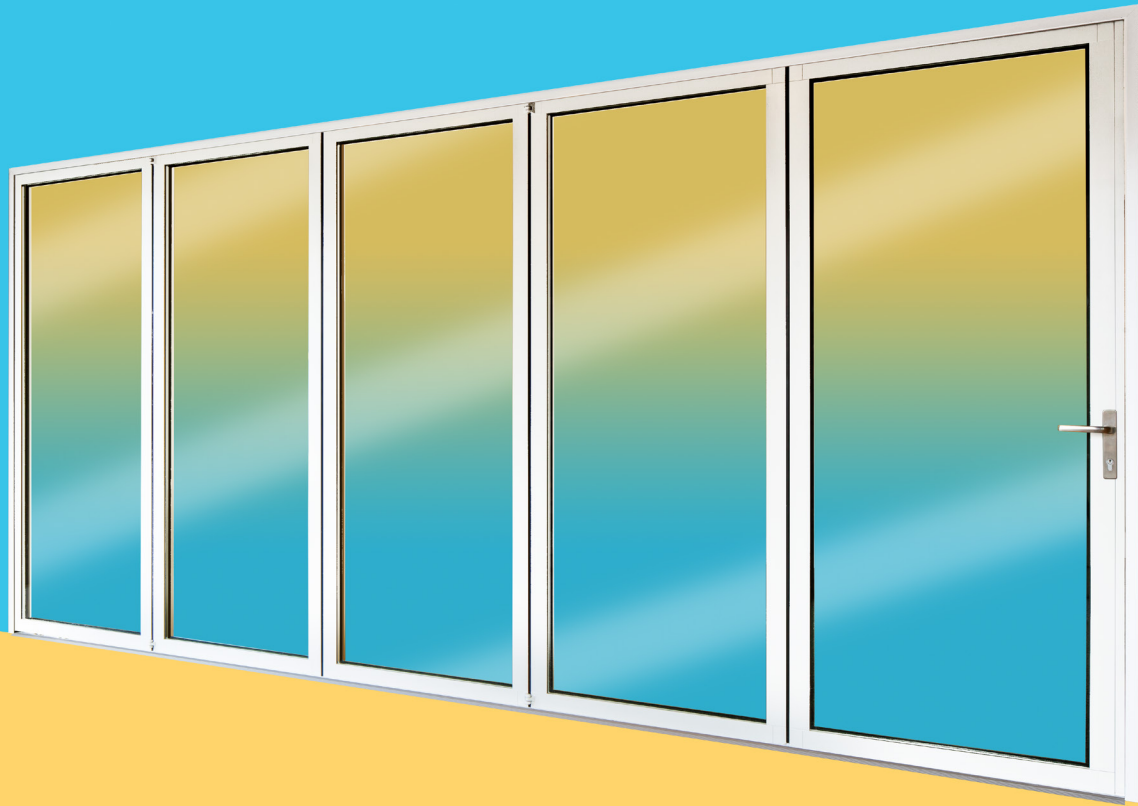

NanaWall SL60B and WA67B—Folding Glass Walls Designed for Builders

If your project requires customization beyond what the SL60B and WA67B offers (greater widths, taller heights, inward opening panels, sill or color choices, etc.), NanaWall offers a complete range of customizable folding glass wall systems in Aluminum, Wood, Aluminum Clad, and Frameless profiles that can meet almost any requirement.

To see the complete range, visit: nanawall.com/folding-glass-walls

THE ONE AND ONLY NANAWALL

NanaWall has reinvented the category of opening glass wall systems. Throughout our 30-plus-year history, we have earned the trust of architects, builders and contractors. As a solutions provider, we reimagine the ways in which buildings, people and the elements interact.

NanaWall®

Nana Wall Systems, Inc.
100 Meadowcreek Drive #250
Corte Madera, CA 94925

800 873 5673
415 383 3148
Fax 415 383 0312

info@nanawall.com
[NanaWall.com](https://nanawall.com)